

1st Floor

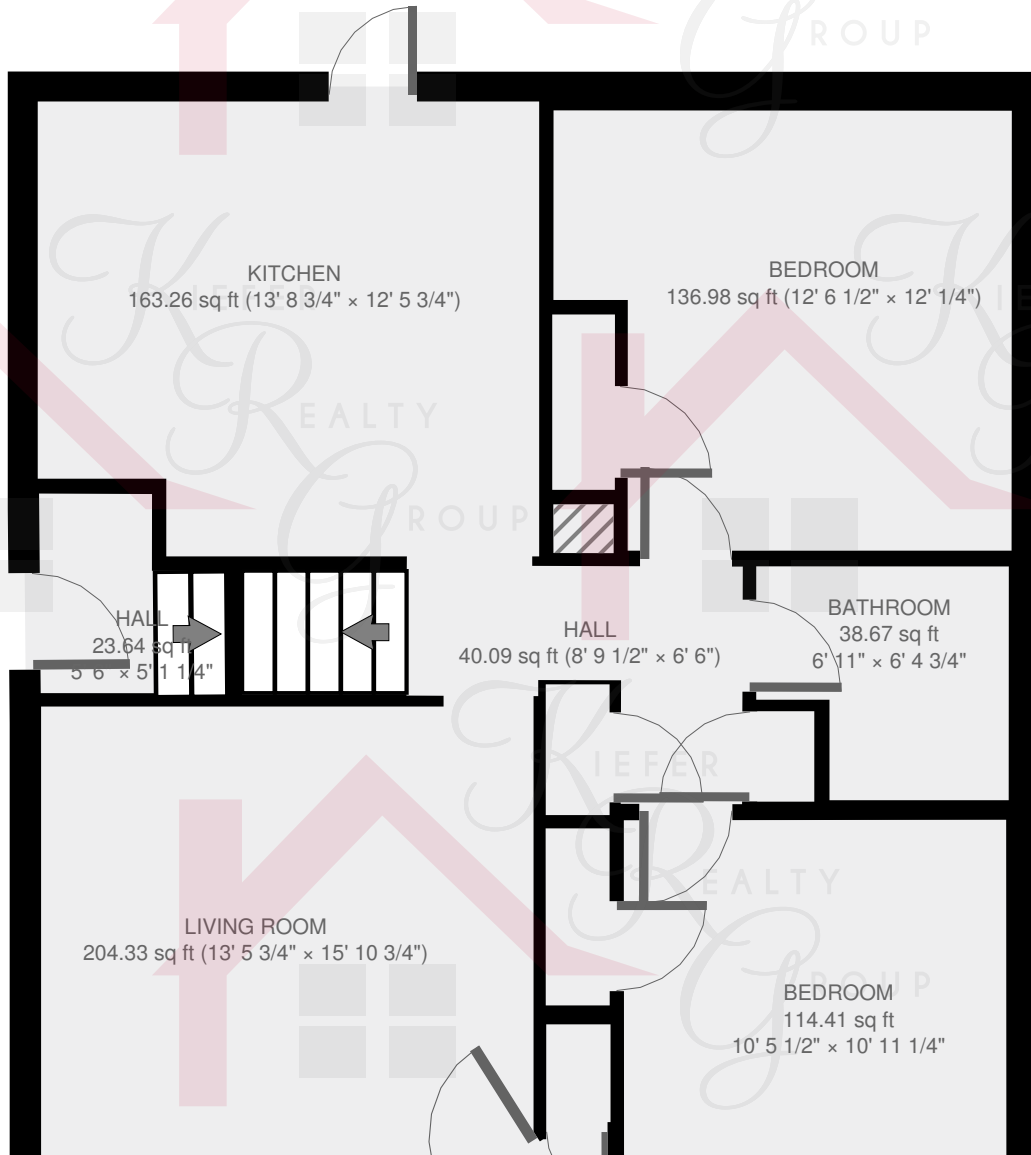

OUT WARRANTY OF ANY KIND. SENSOPIA DISCLAIMS ANY WARRANTY INCLUDING, WITHOUT LIMITATION, SATISFACTORY QUALITY OR ACCURACY OF DIMENSIONS.

3482 Cedarbrook Road, University Heights, OH 44118

Keith Kiefer, CNE, RRS, Realtor
Certified Negotiation Expert
Residential Relocation Specialist

216-403-1797

keith@kieferrealtygroup.com

KieferRealtyGroup.com

KRGListings.com



kw HEIGHTS
KELLERWILLIAMS
GREATER CLEVELAND

All information deemed to be reliable but not guaranteed. This is not intended to solicit currently listed properties. Equal housing opportunities.

Living Room

Width: 13' 5 3/4"
Length: 15' 10 3/4"
Area: 204.33 sq ft
Perimeter: 57' 5"

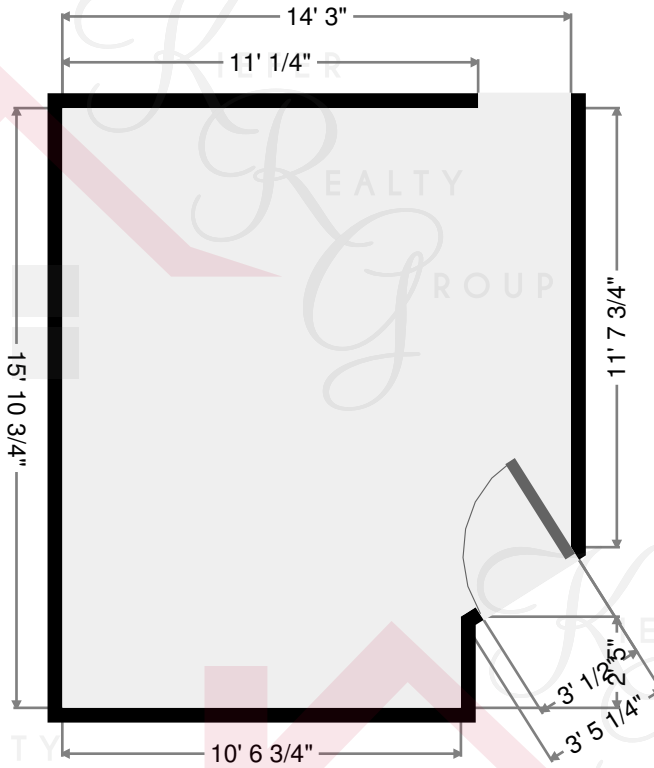
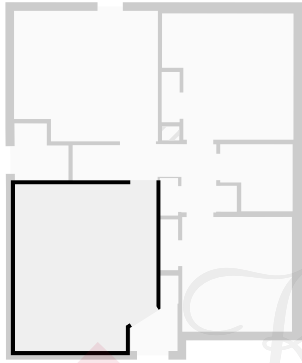

Hall

Width: 4' 1/2"
Length: 4' 5 3/4"
Area: 15.73 sq ft
Perimeter: 15' 10"

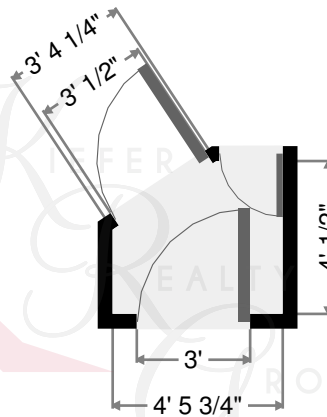
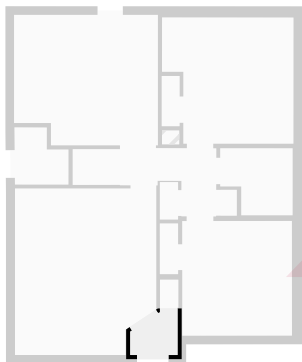

THIS FLOORPLAN IS PROVIDED WITHOUT WARRANTY OF ANY KIND. SENSOPIA DISCLAIMS ANY WARRANTY INCLUDING, WITHOUT LIMITATION, SATISFACTORY QUALITY OR ACCURACY OF DIMENSIONS.

Keith Kiefer, CNE, RRS, Realtor
Certified Negotiation Expert
Residential Relocation Specialist

216-403-1797

KieferRealtyGroup@gmail.com

KieferRealtyGroup.com



Closet

Width: 1' 9 1/4"
 Length: 2' 7 3/4"
 Area: 4.71 sq ft
 Perimeter: 8' 10 1/2"

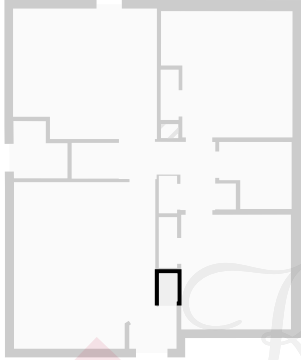

Hall

Width: 6' 6"
 Length: 8' 9 1/2"
 Area: 40.09 sq ft
 Perimeter: 31' 5 3/4"

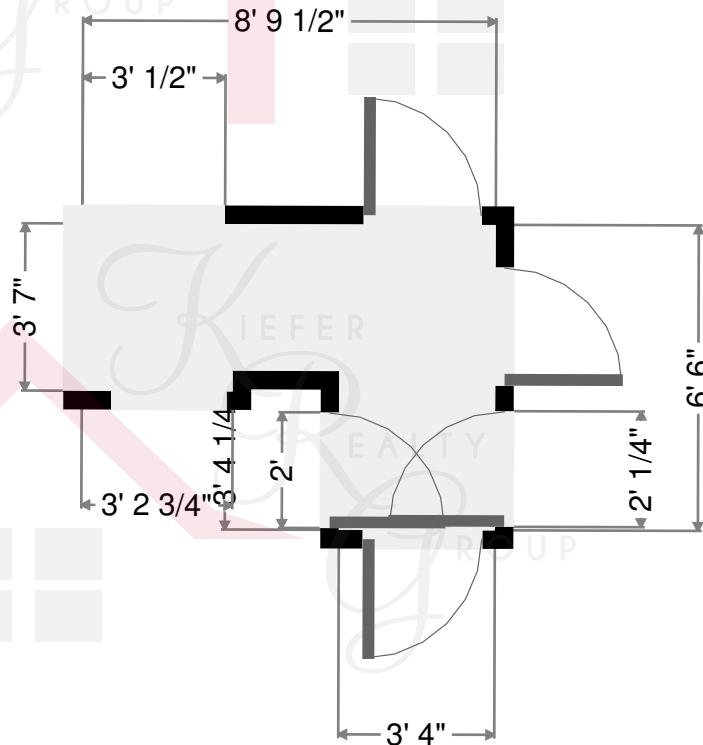
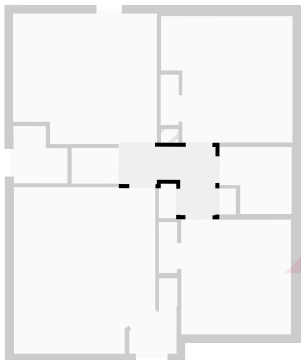

THIS FLOORPLAN IS PROVIDED WITHOUT WARRANTY OF ANY KIND. SENSIOPIA DISCLAIMS ANY WARRANTY INCLUDING, WITHOUT LIMITATION, SATISFACTORY QUALITY OR ACCURACY OF DIMENSIONS.

Keith Kiefer, CNE, RRS, Realtor
 Certified Negotiation Expert
 Residential Relocation Specialist

216-403-1797

KieferRealtyGroup@gmail.com

KieferRealtyGroup.com



kw HEIGHTS
 KELLERWILLIAMS
 GREATER CLEVELAND

Closet

Width: 1' 9"
Length: 3' 7 1/4"
Area: 6.24 sq ft
Perimeter: 10' 7 3/4"

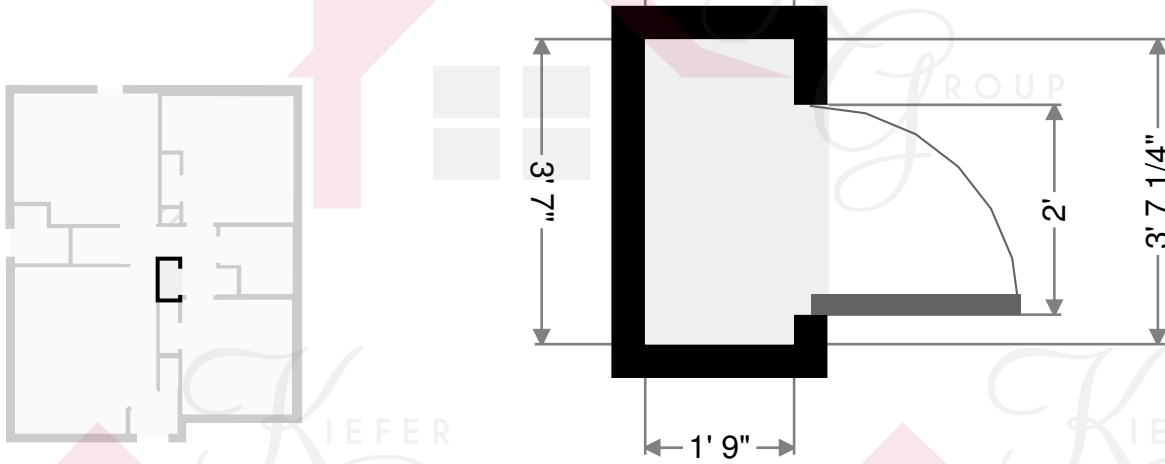

Closet

Width: 1' 9 1/4"
Length: 4' 10"
Area: 8.47 sq ft
Perimeter: 13' 2 1/4"

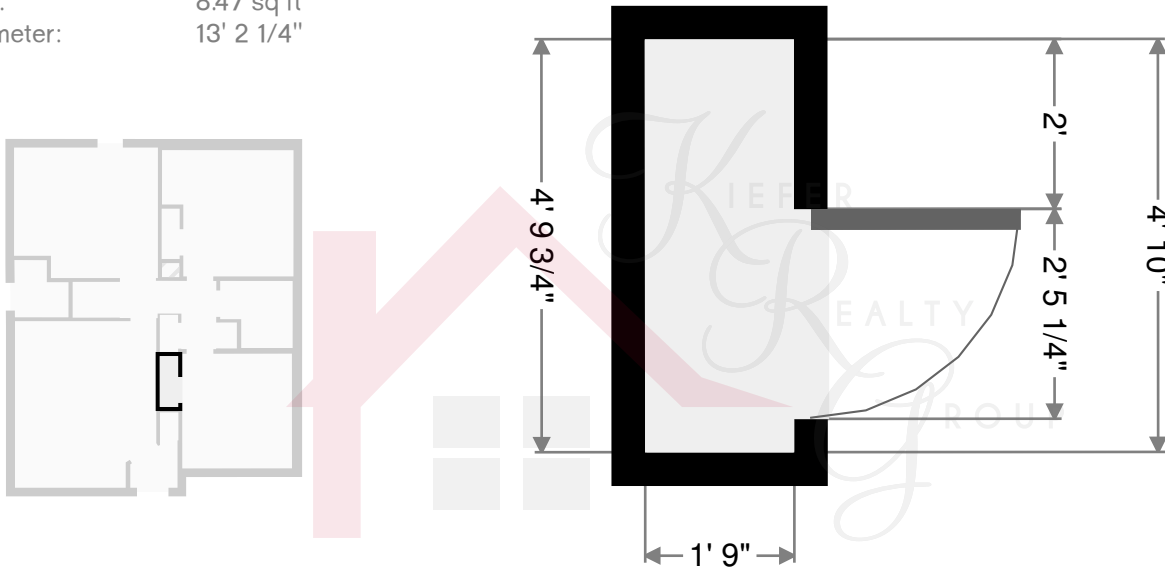

THIS FLOORPLAN IS PROVIDED WITHOUT WARRANTY OF ANY KIND. SENSOPIA DISCLAIMS ANY WARRANTY INCLUDING, WITHOUT LIMITATION, SATISFACTORY QUALITY OR ACCURACY OF DIMENSIONS.

Keith Kiefer, CNE, RRS, Realtor
Certified Negotiation Expert
Residential Relocation Specialist

216-403-1797

KieferRealtyGroup@gmail.com

KieferRealtyGroup.com

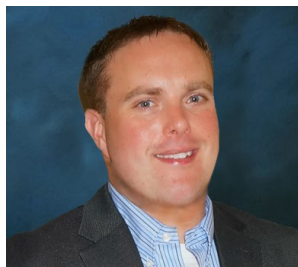

Bedroom

Width: 10' 5 1/2"
Length: 10' 11 1/4"
Area: 114.41 sq ft
Perimeter: 42' 9 1/2"

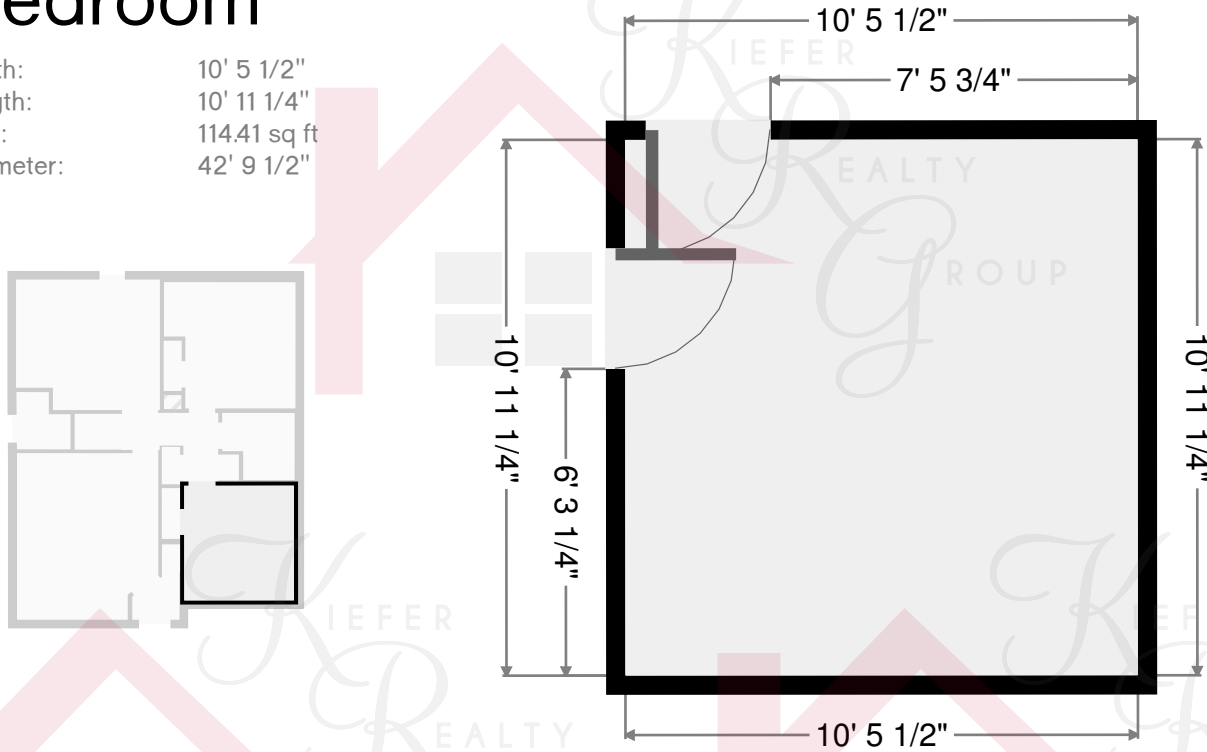

Closet

Width: 1' 6 3/4"
Length: 2' 5 1/2"
Area: 3.86 sq ft
Perimeter: 8' 3/4"



THIS FLOORPLAN IS PROVIDED WITHOUT WARRANTY OF ANY KIND. SENSOPIA DISCLAIMS ANY WARRANTY INCLUDING, WITHOUT LIMITATION, SATISFACTORY QUALITY OR ACCURACY OF DIMENSIONS.

Keith Kiefer, CNE, RRS, Realtor
Certified Negotiation Expert
Residential Relocation Specialist

216-403-1797

KieferRealtyGroup@gmail.com

KieferRealtyGroup.com



Bathroom

Width: 6' 4 3/4"
Length: 6' 11"
Area: 38.67 sq ft
Perimeter: 26' 7 1/4"

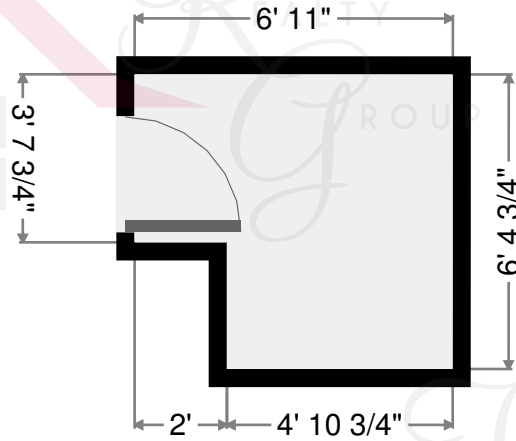
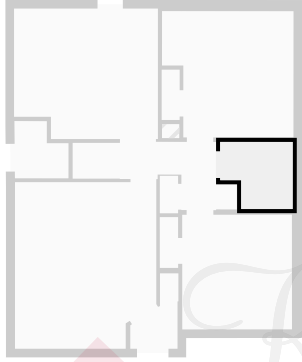

Bedroom

Width: 12' 1/4"
Length: 12' 6 1/2"
Area: 136.98 sq ft
Perimeter: 49' 1 3/4"

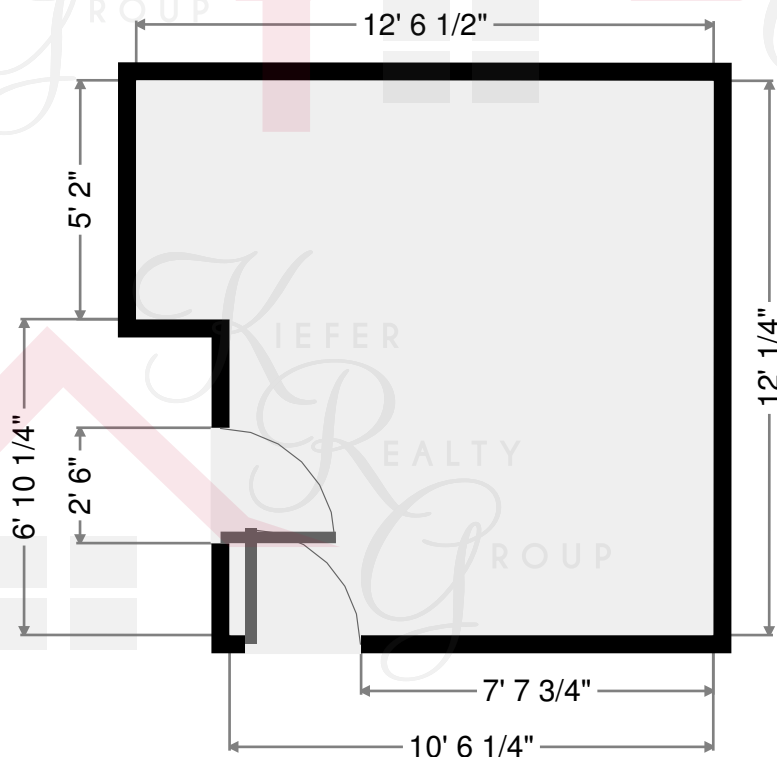
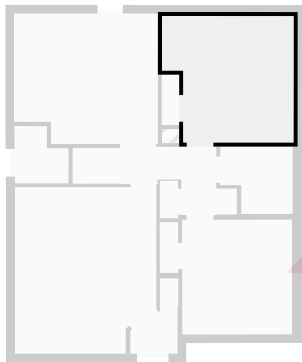

THIS FLOORPLAN IS PROVIDED WITHOUT WARRANTY OF ANY KIND. SENSOPIA DISCLAIMS ANY WARRANTY INCLUDING, WITHOUT LIMITATION, SATISFACTORY QUALITY OR ACCURACY OF DIMENSIONS.

Keith Kiefer, CNE, RRS, Realtor
Certified Negotiation Expert
Residential Relocation Specialist

216-403-1797

KieferRealtyGroup@gmail.com

KieferRealtyGroup.com



Closet

Width: 1' 8 3/4"
 Length: 4' 9 1/2"
 Area: 8.22 sq ft
 Perimeter: 13' 1/4"

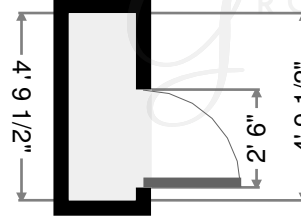
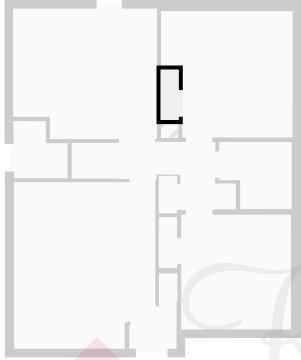

Kitchen

Width: 12' 5 3/4"
 Length: 13' 8 3/4"
 Area: 163.26 sq ft
 Perimeter: 52' 4"

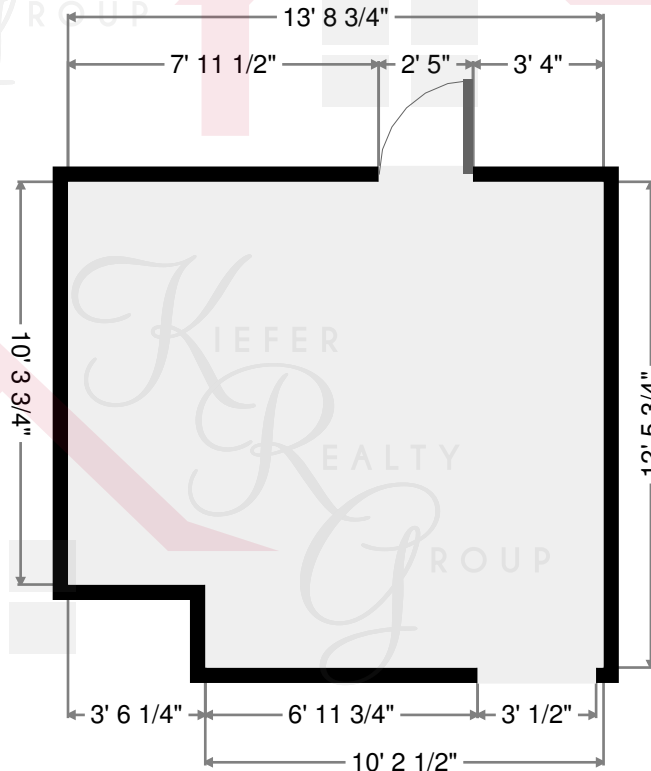
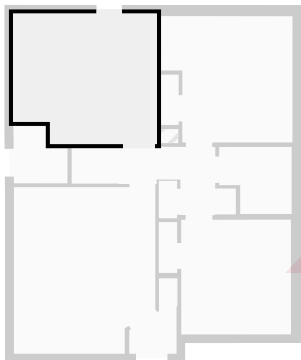

THIS FLOORPLAN IS PROVIDED WITHOUT WARRANTY OF ANY KIND. SENSOPIA DISCLAIMS ANY WARRANTY INCLUDING, WITHOUT LIMITATION, SATISFACTORY QUALITY OR ACCURACY OF DIMENSIONS.

Keith Kiefer, CNE, RRS, Realtor
 Certified Negotiation Expert
 Residential Relocation Specialist

216-403-1797

KieferRealtyGroup@gmail.com

KieferRealtyGroup.com



kw HEIGHTS
 KELLER WILLIAMS
 GREATER CLEVELAND

Stairway

Width: 3' 5"
 Length: 4' 6"
 Area: 15.37 sq ft
 Perimeter: 15' 10"

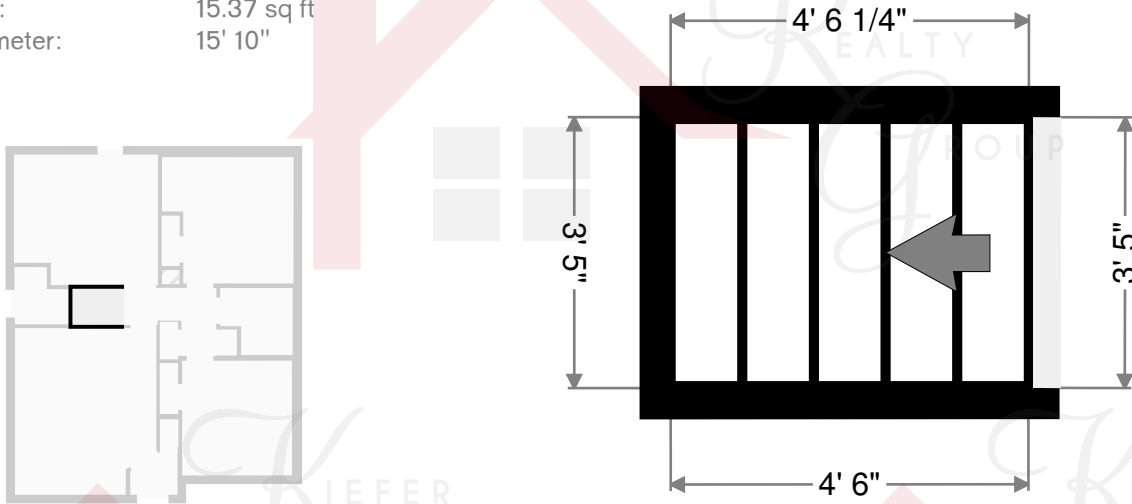

Hall

Width: 5' 1 1/4"
 Length: 5' 6"
 Area: 23.64 sq ft
 Perimeter: 21' 2 1/4"

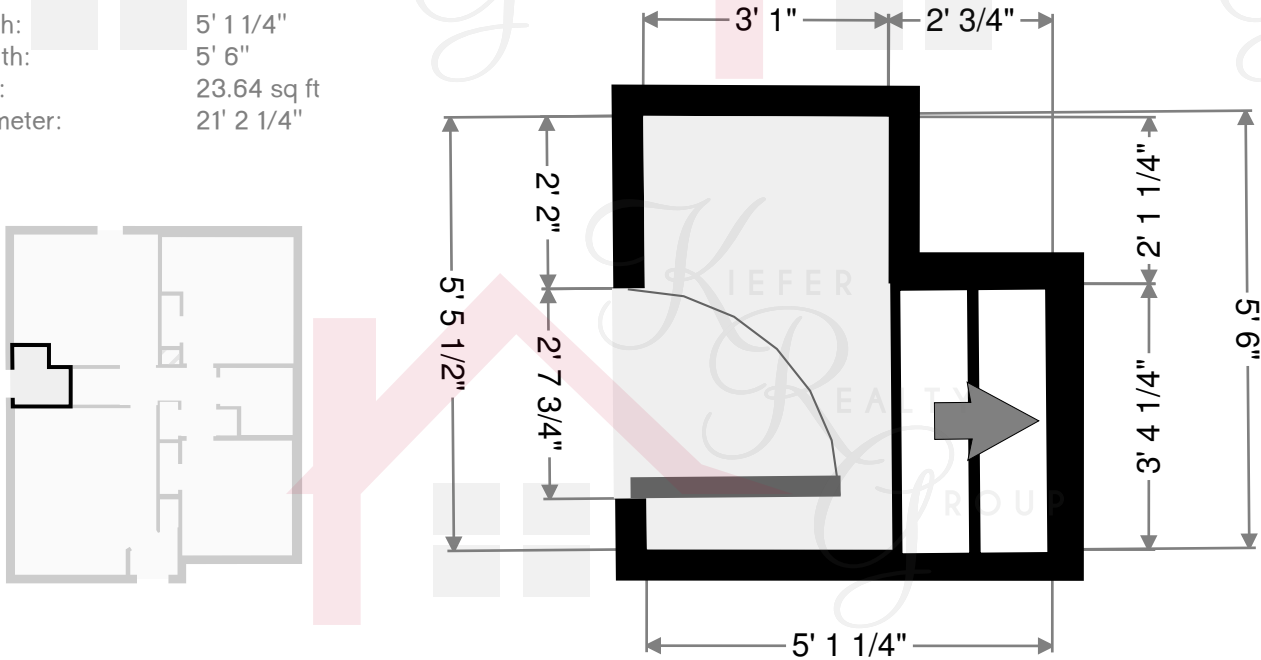

THIS FLOORPLAN IS PROVIDED WITHOUT WARRANTY OF ANY KIND. SENSOPIA DISCLAIMS ANY WARRANTY INCLUDING, WITHOUT LIMITATION, SATISFACTORY QUALITY OR ACCURACY OF DIMENSIONS.

Keith Kiefer, CNE, RRS, Realtor
 Certified Negotiation Expert
 Residential Relocation Specialist

216-403-1797

KieferRealtyGroup@gmail.com

KieferRealtyGroup.com



kw HEIGHTS
 KELLERWILLIAMS
 GREATER CLEVELAND

2nd Floor



WITHOUT WARRANTY OF ANY KIND. SENSOPRIA DISCLAIMS ANY WARRANTY INCLUDING, WITHOUT LIMITATION, SATISFACTORY QUALITY OR ACCURACY OF DIMENSIONS.

3482 Cedarbrook Road, University Heights, OH 44118

Keith Kiefer, CNE, RRS, Realtor
Certified Negotiation Expert
Residential Relocation Specialist

216-403-1797

keith@kieferrealtygroup.com

KieferRealtyGroup.com

KRGListings.com



All information deemed to be reliable but not guaranteed. This is not intended to solicit currently listed properties. Equal housing opportunities.

Bedroom

Width: 9' 8 3/4"
 Length: 12' 7 1/4"
 Area: 122.48 sq ft
 Perimeter: 44' 7 3/4"

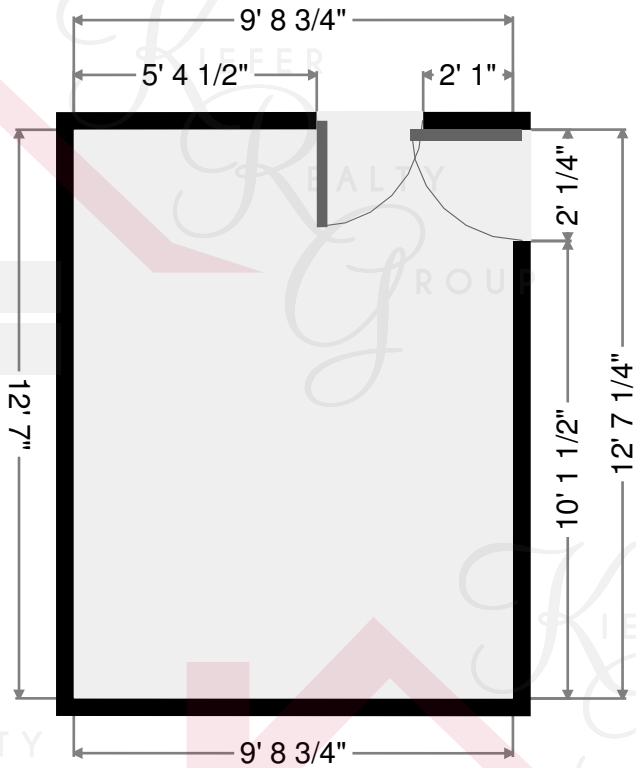
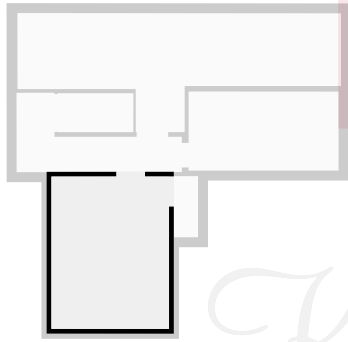

Closet

Width: 2'
 Length: 5' 3/4"
 Area: 10.14 sq ft
 Perimeter: 14' 1 1/2"

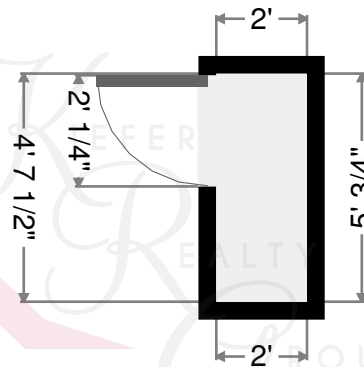
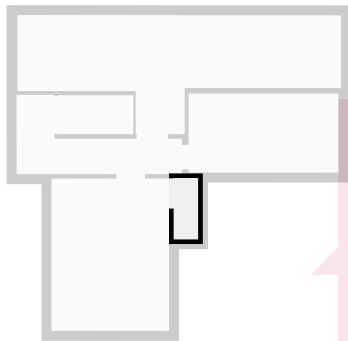

THIS FLOORPLAN IS PROVIDED WITHOUT WARRANTY OF ANY KIND. SENSOPIA DISCLAIMS ANY WARRANTY INCLUDING, WITHOUT LIMITATION, SATISFACTORY QUALITY OR ACCURACY OF DIMENSIONS.

Keith Kiefer, CNE, RRS, Realtor
 Certified Negotiation Expert
 Residential Relocation Specialist

216-403-1797

KieferRealtyGroup@gmail.com

KieferRealtyGroup.com



kw HEIGHTS
 KELLERWILLIAMS
 GREATER CLEVELAND

Hall

Width: 6' 7"
 Length: 13' 7 3/4"
 Area: 51.39 sq ft
 Perimeter: 40' 5 3/4"

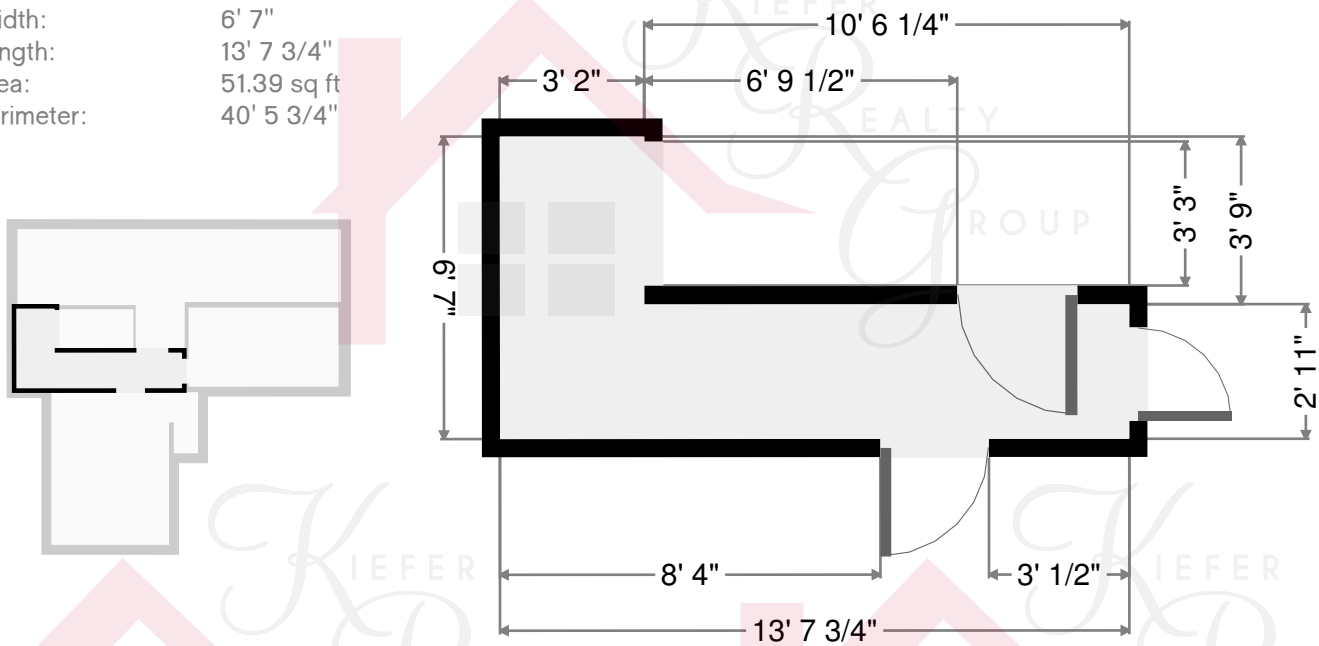

Stairway

Width: 3' 2 3/4"
 Length: 6' 3 1/4"
 Area: 20.23 sq ft
 Perimeter: 19'

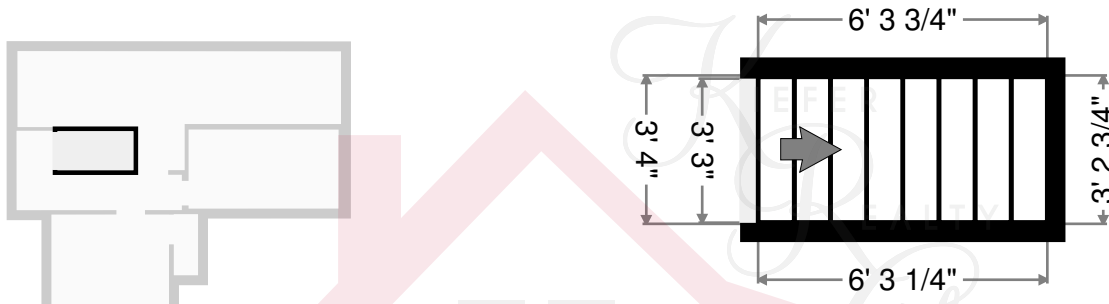

THIS FLOORPLAN IS PROVIDED WITHOUT WARRANTY OF ANY KIND. SENSOPIA DISCLAIMS ANY WARRANTY INCLUDING, WITHOUT LIMITATION, SATISFACTORY QUALITY OR ACCURACY OF DIMENSIONS.

Keith Kiefer, CNE, RRS, Realtor
 Certified Negotiation Expert
 Residential Relocation Specialist

216-403-1797

KieferRealtyGroup@gmail.com

KieferRealtyGroup.com



Bathroom

Width: 6' 6"
 Length: 12' 4 3/4"
 Area: 81.02 sq ft
 Perimeter: 37' 10 1/2"

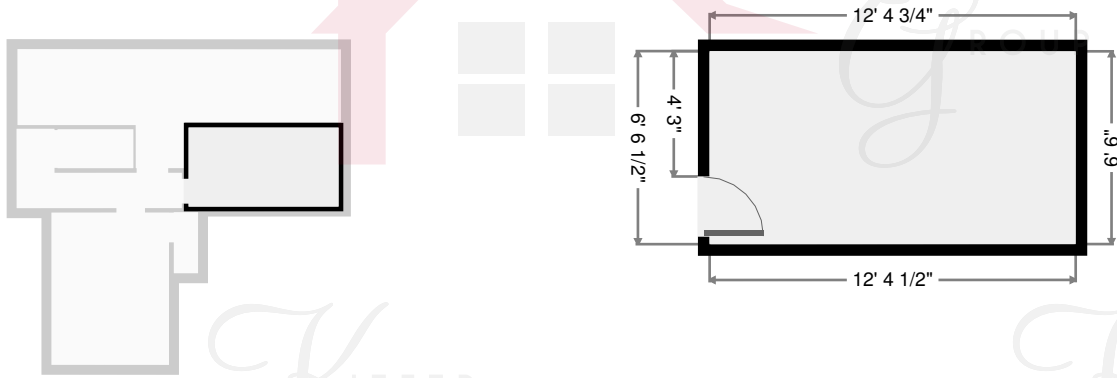

Other

Width: 9' 10"
 Length: 26' 9 1/2"
 Area: 179.02 sq ft
 Perimeter: 73' 2"

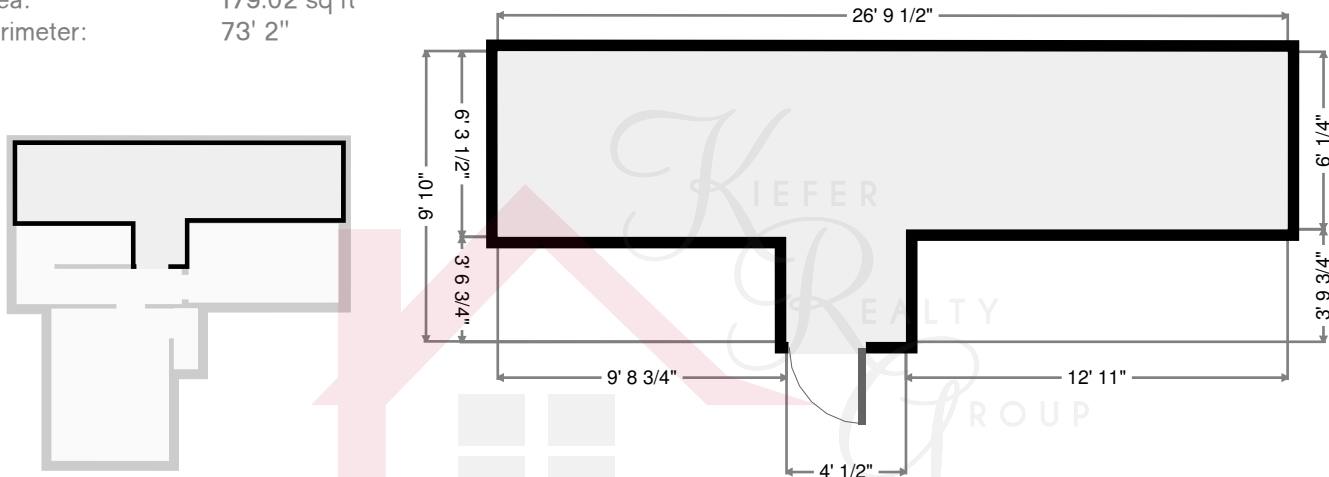

THIS FLOORPLAN IS PROVIDED WITHOUT WARRANTY OF ANY KIND. SENSOPIA DISCLAIMS ANY WARRANTY INCLUDING, WITHOUT LIMITATION, SATISFACTORY QUALITY OR ACCURACY OF DIMENSIONS.

Keith Kiefer, CNE, RRS, Realtor
 Certified Negotiation Expert
 Residential Relocation Specialist

216-403-1797

KieferRealtyGroup@gmail.com

KieferRealtyGroup.com

